

PLAN OF TOMB 01

PROJECT PERSERVATION & RENOVATION OF	LOCATION NEAR TAL. IGH DISTRICT PARK	JOB		CAD BY;	DATE
---	---	-----	--	---------	------

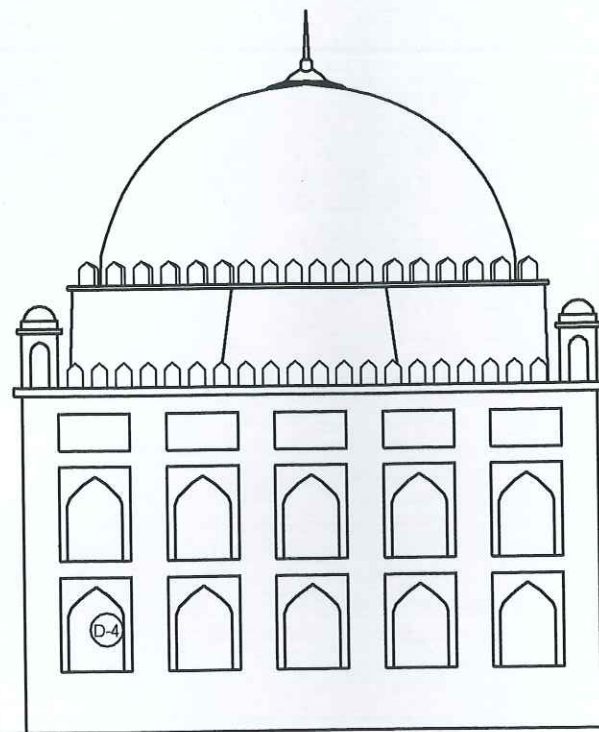

PROPOSED LEFT SIDE ELEVATION

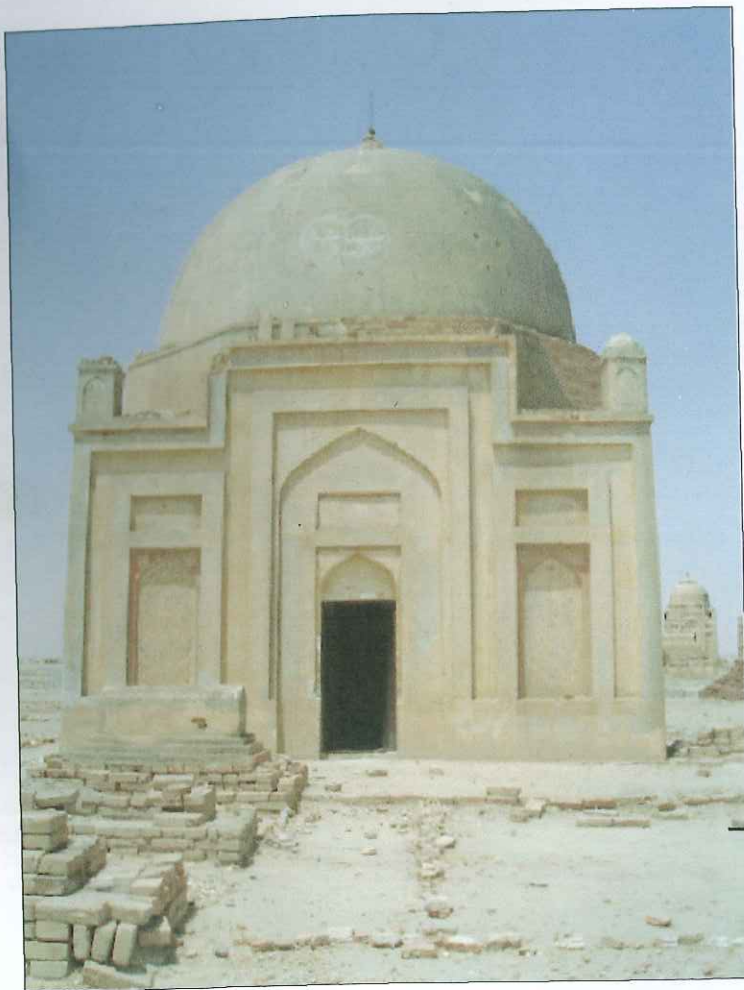
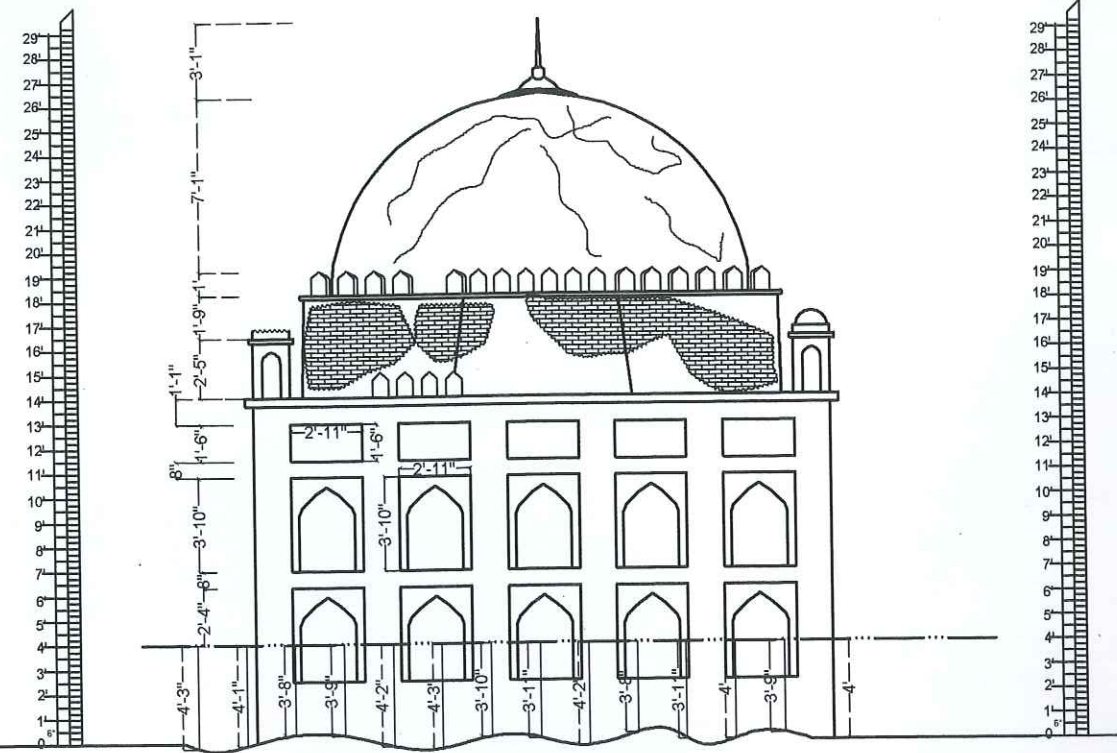

EXISTING LEFT SIDE ELEVATION

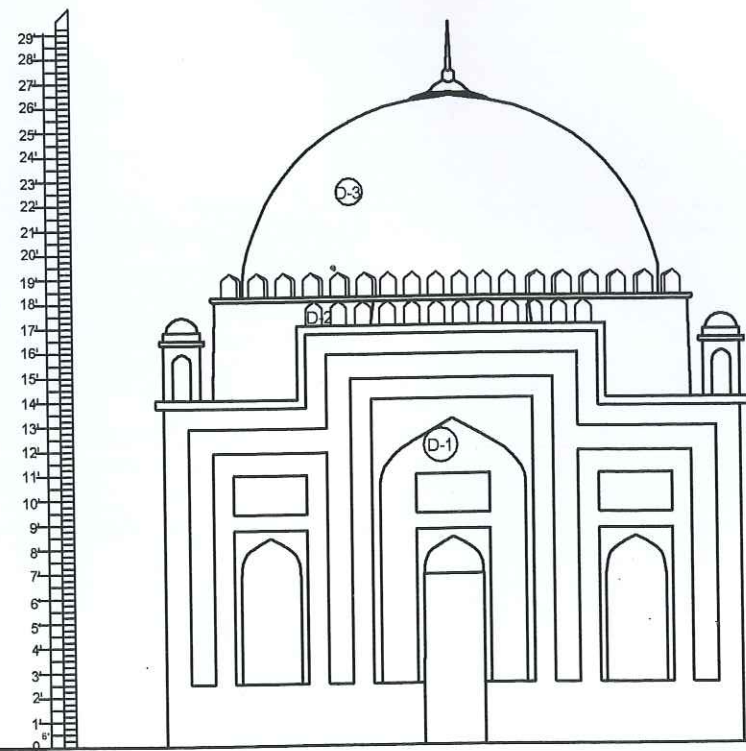
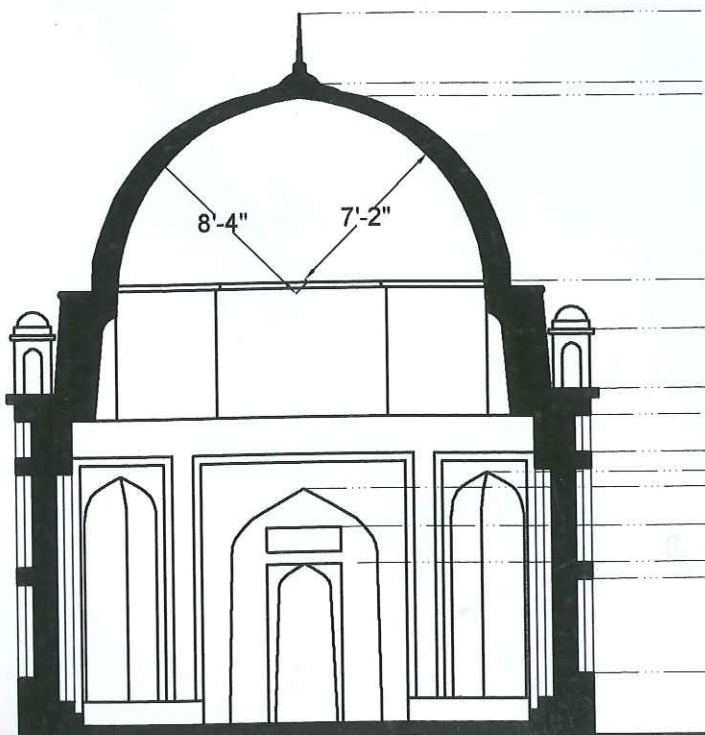

PROPOSED FRONT ELEVATION

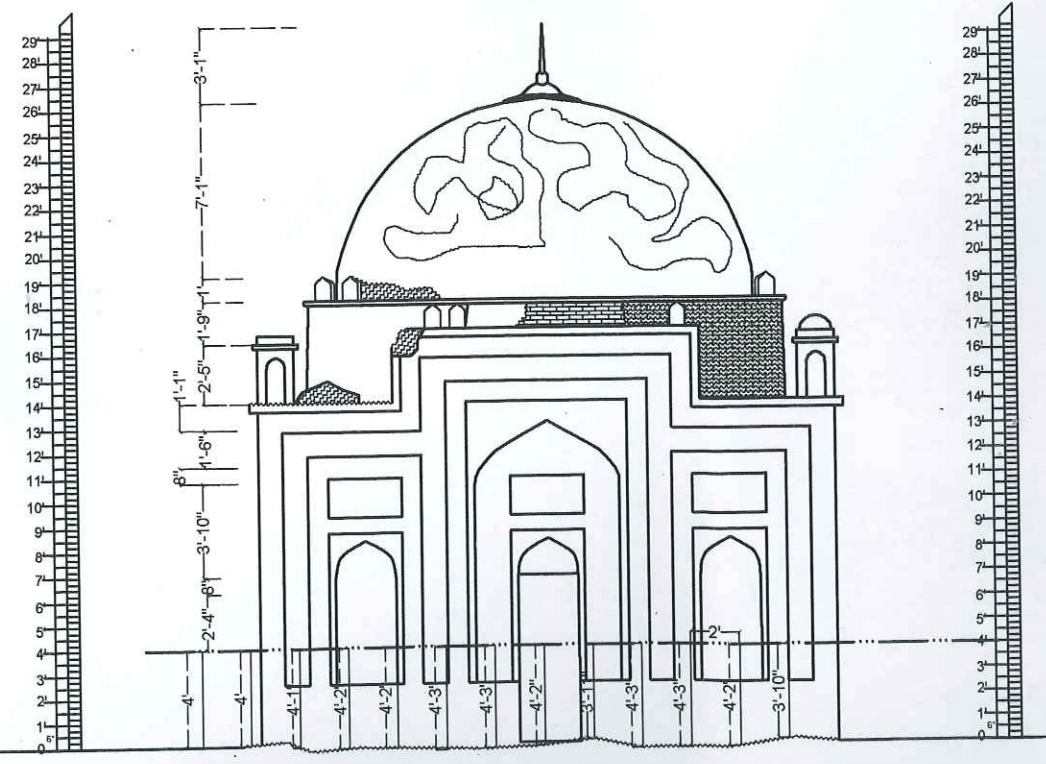

EXISTING FRONT ELEVATION

PROJECT

LOCATION

JOB

DEVELOPED BY;

DATE

RECONSTRUCTION OF

NEAR FAH ROAD DISTRICT DARY

ARCH: IFTIKHAR AHMED KAHLORO

05.05.2008

PROJECT
PRESERVATION & RENOVATION OF
JAMALI JA QUBBA

LOCATION
TAL: JOHI DISTRICT DADU

JOB
TOMB 02

DEPARTMENT OF ANTIQUITIES
GOVT. OF SINDH

CAD BY:
ARCH: IFTIKHAR AHMED KALHORO

DATE
05.05.2008

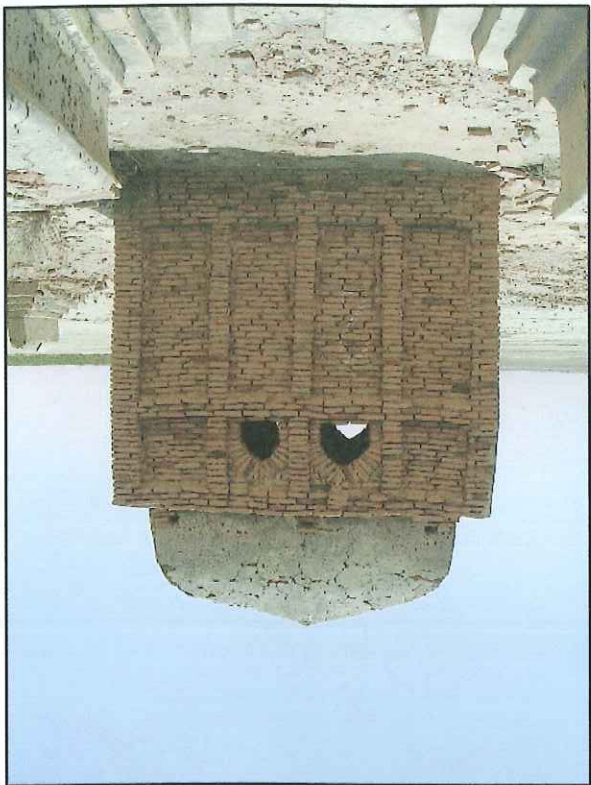
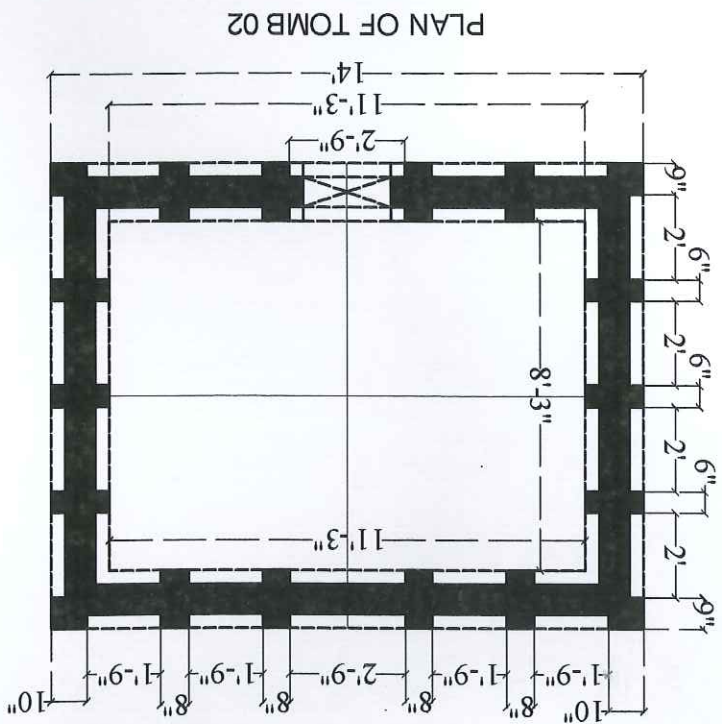

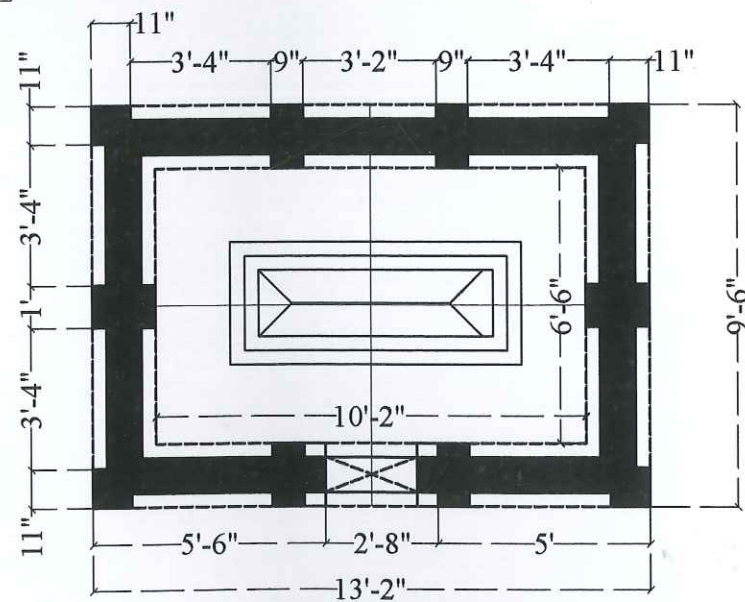
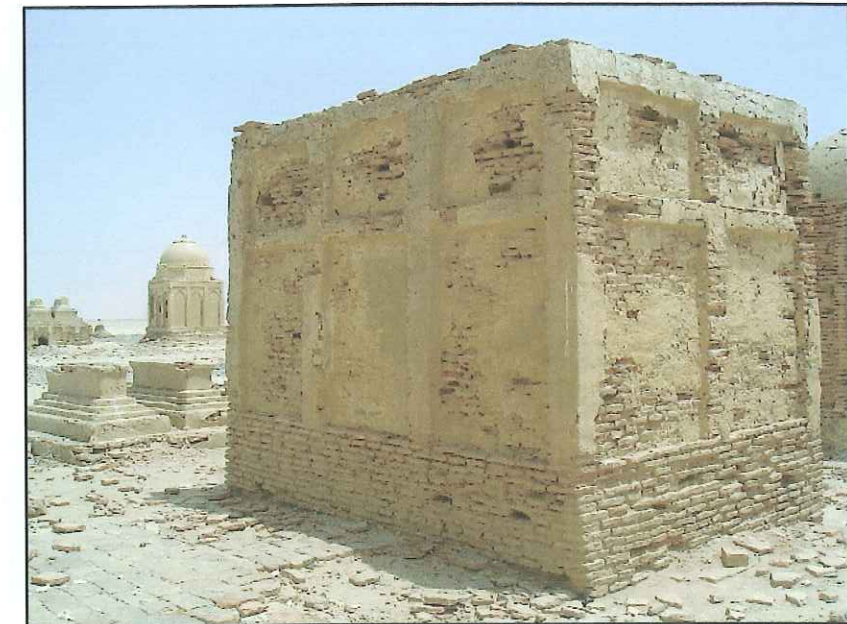

PLAN OF TOMB 03



PROJECT
PERSERVATION & RENOVATION OF

LOCATION
TAL: JOHLI DISTRICT DADU

JOB

DELVELOPED BY;
ARCH: IFTIKHAR AHMED KALHORO

DATE
05.05.2008

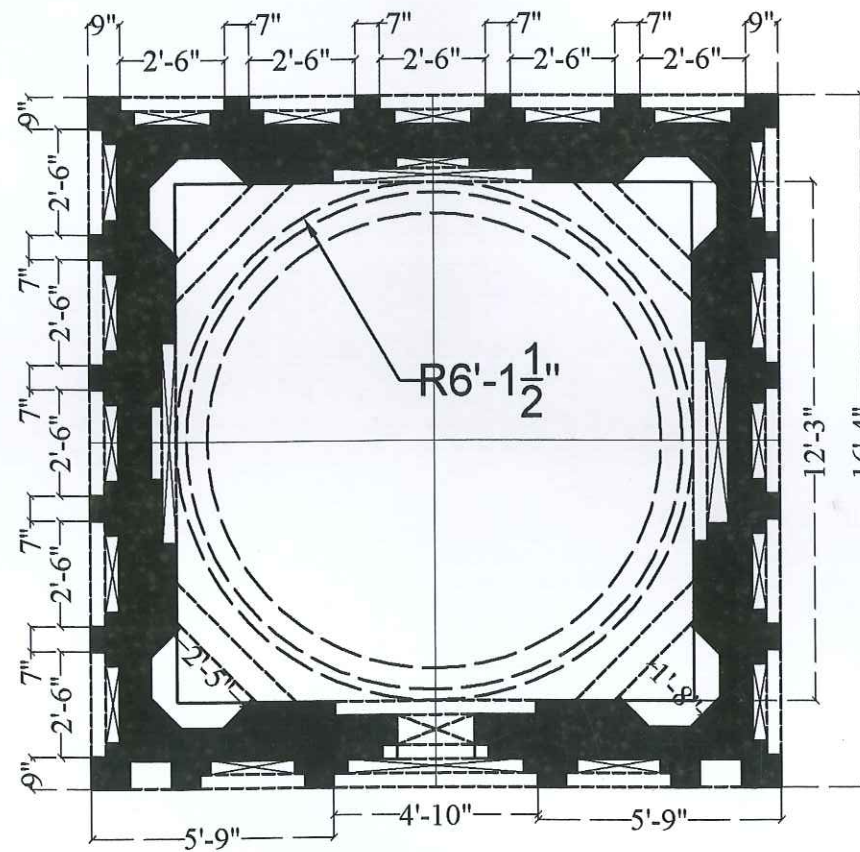
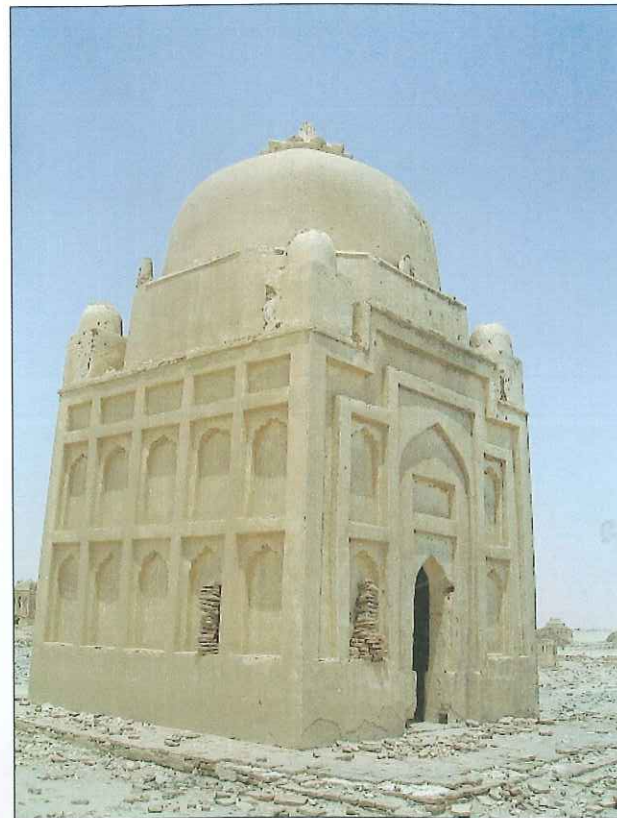
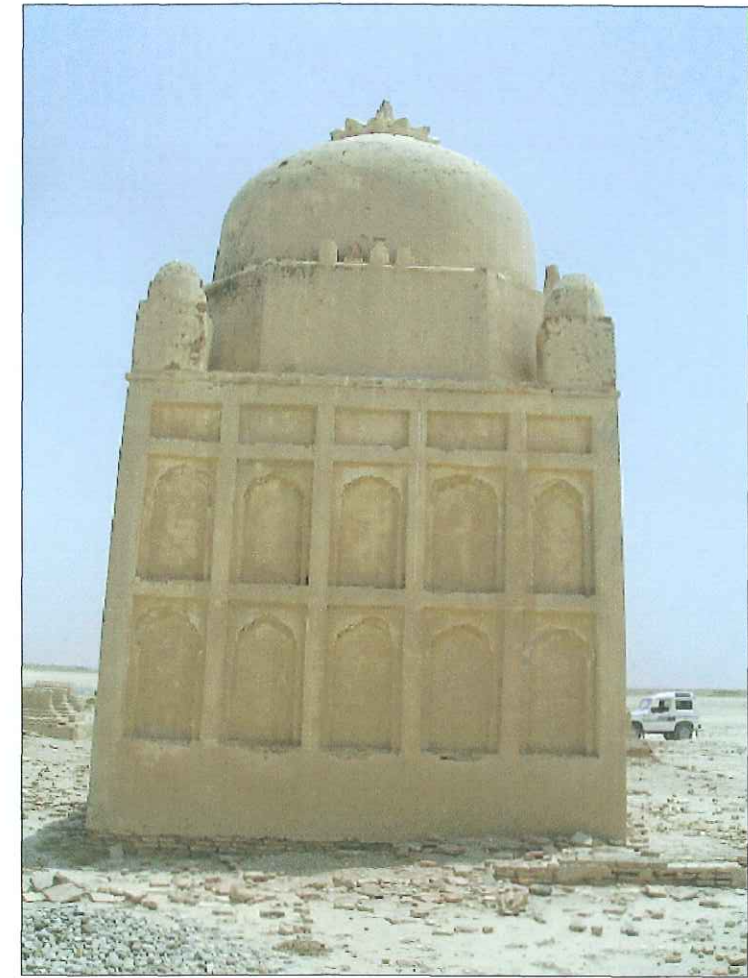
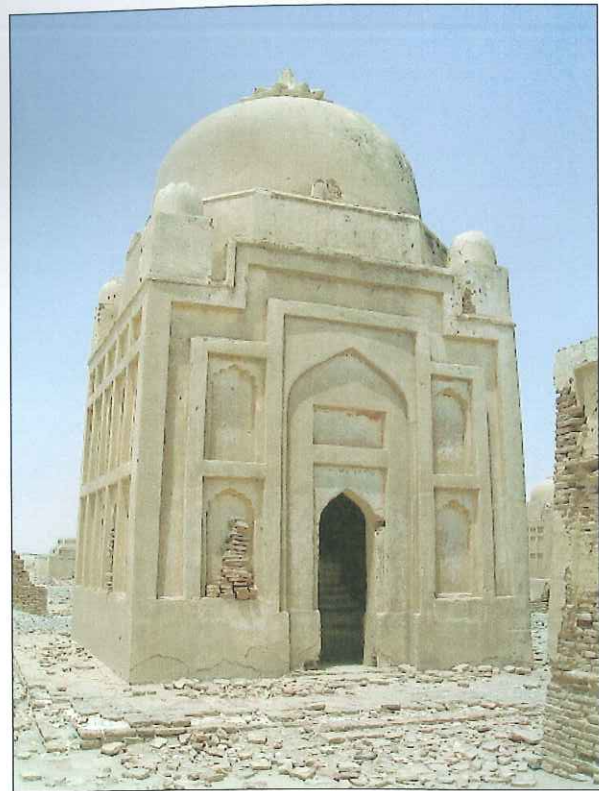

PLAN OF TOMB 04

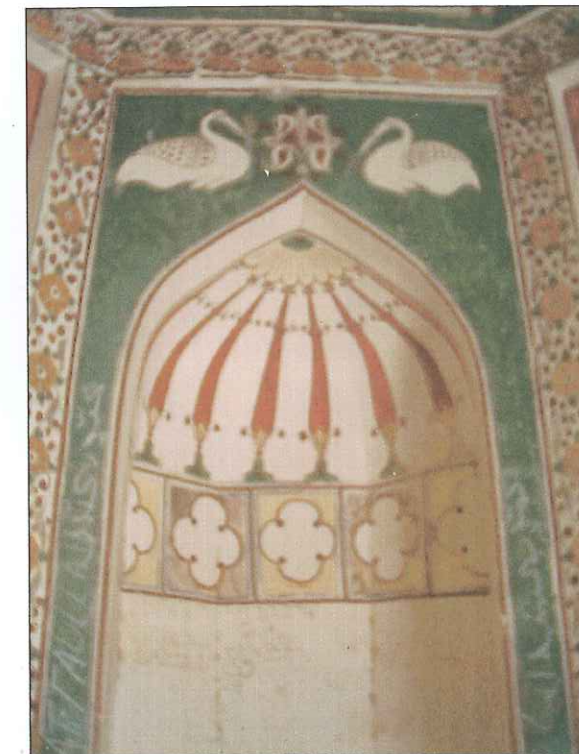

PROJECT
PERSERVATION & RENOVATION OF

LOCATION
TAI : JOHI DISTRICT DADI

JOB

DELVELOPED BY;
ARCH: IFTIKHAR AHMED KALHORO

DATE
05.05.2008

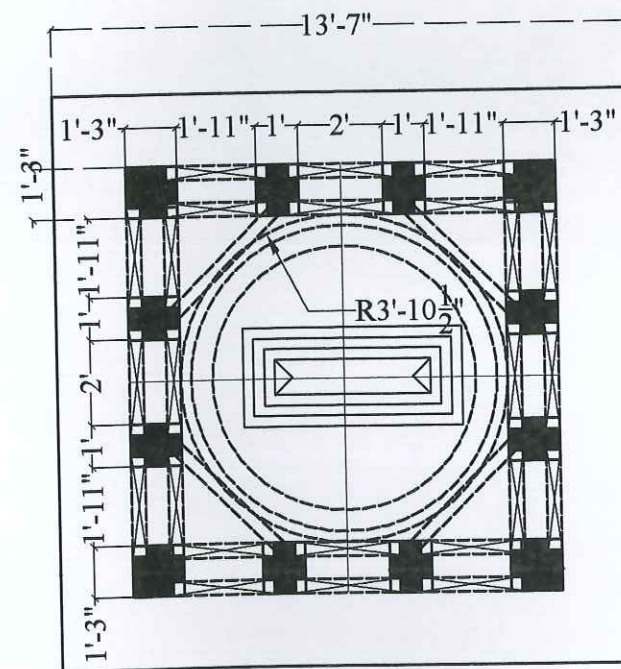
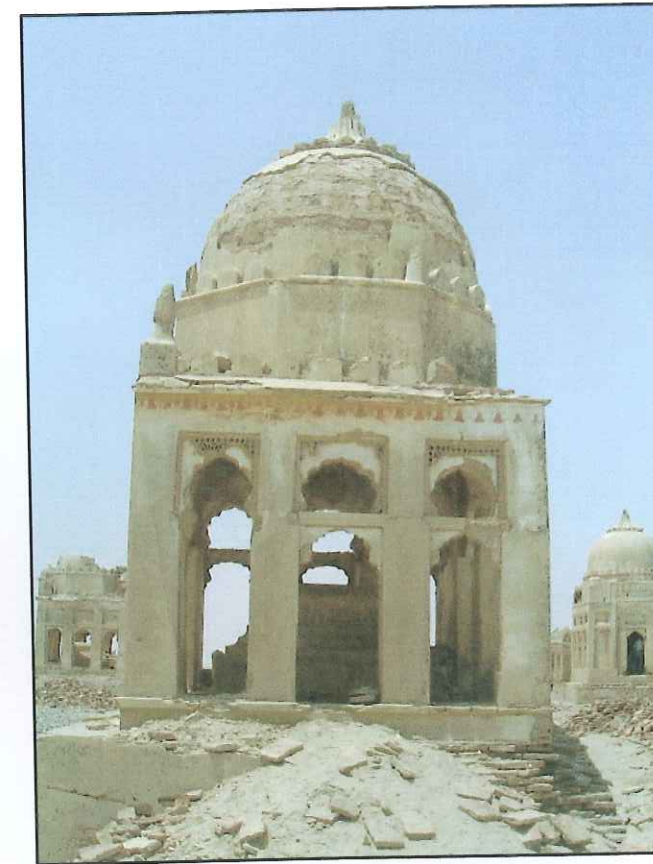
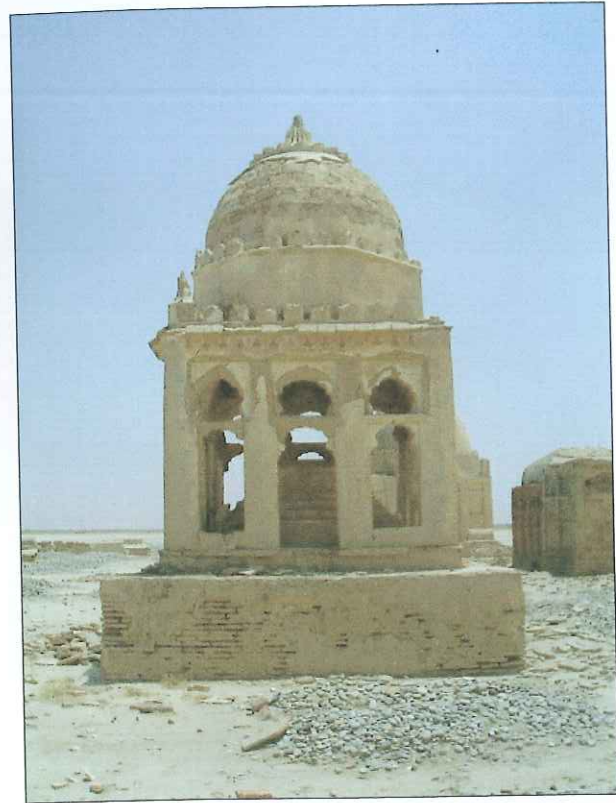

PLAN OF TOMB 05

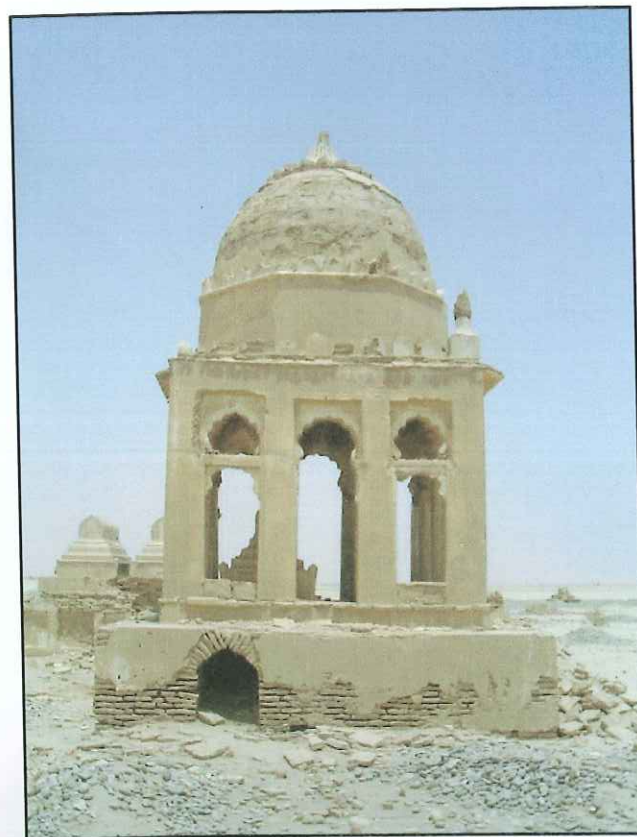

PROJECT

LOCATION

JOB

DEVELOPED BY;
ARCH: IFTIKHAR AHMED KALHORO

DATE
05.05.2008

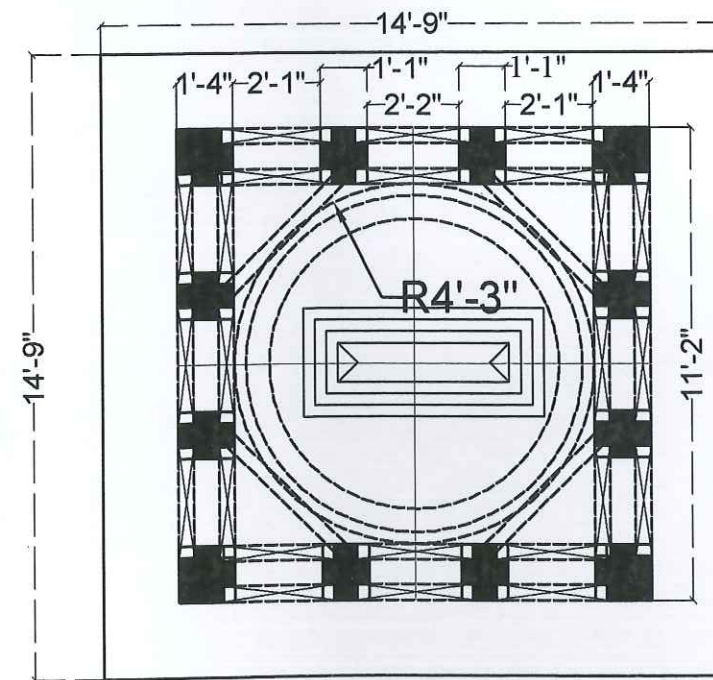
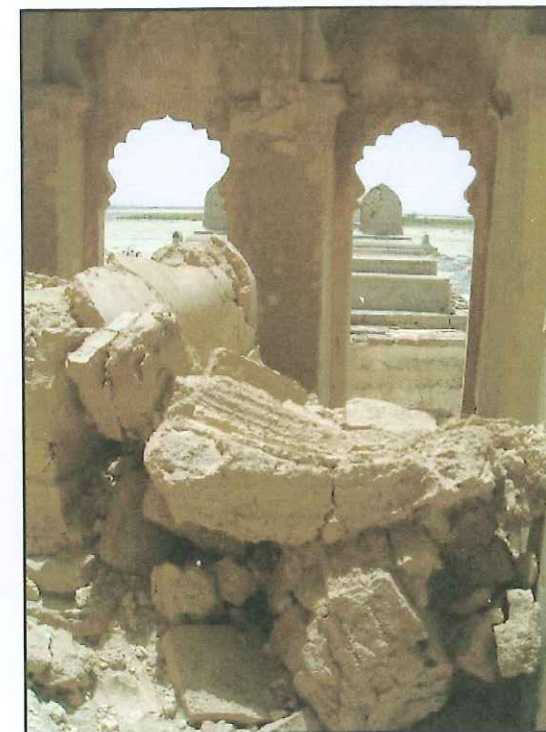
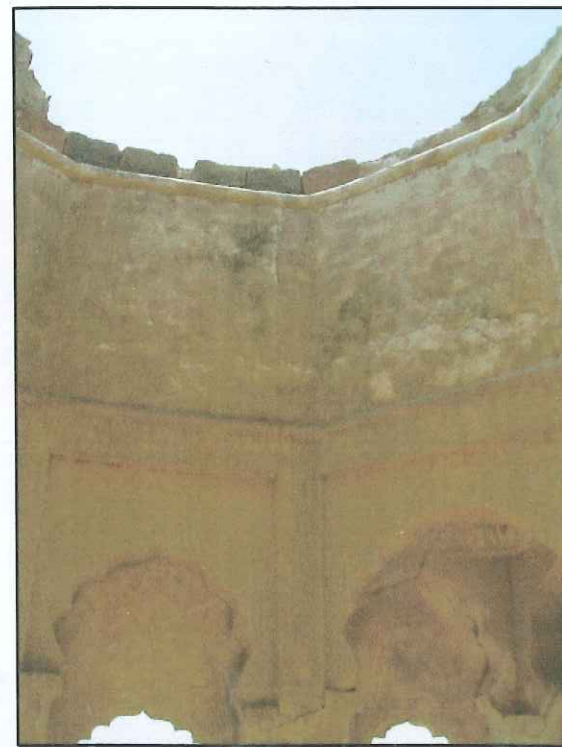
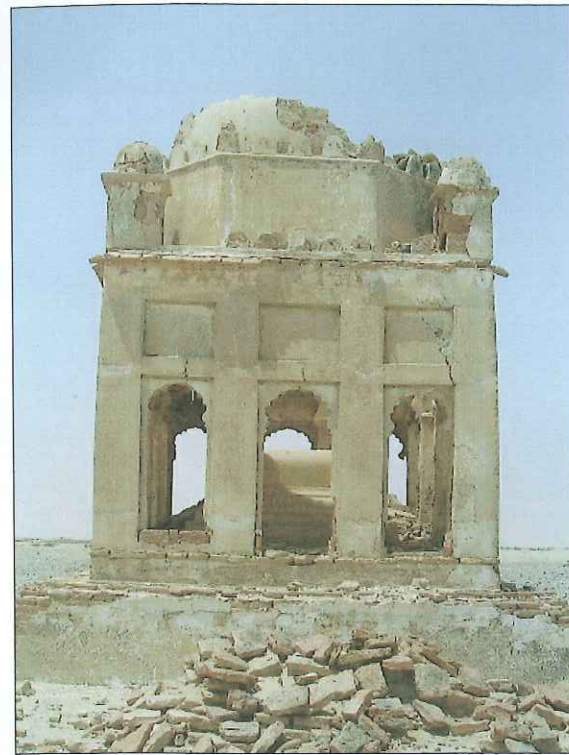

PLAN OF TOMB 06

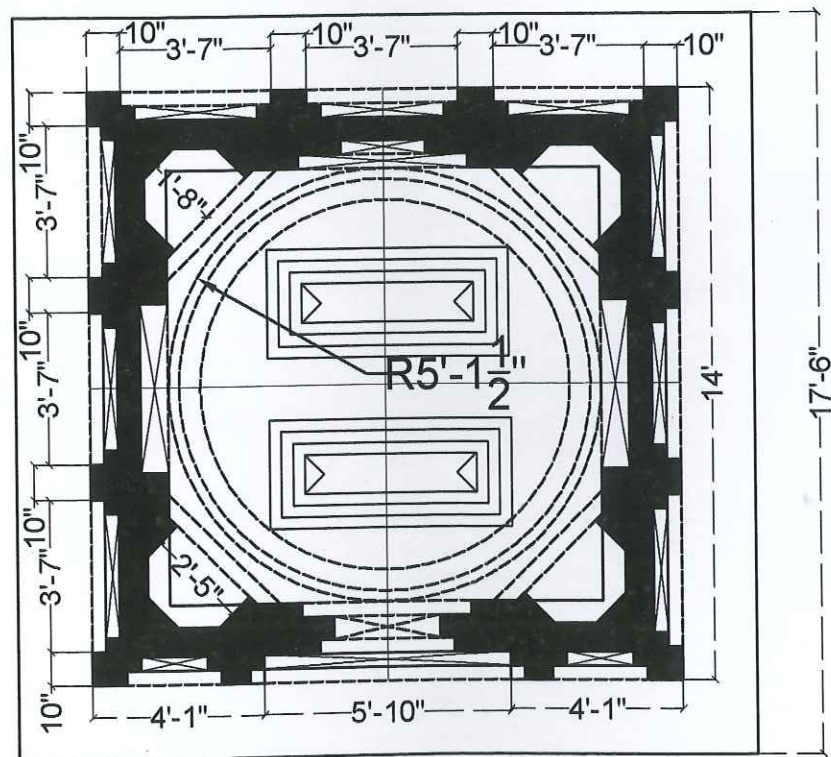
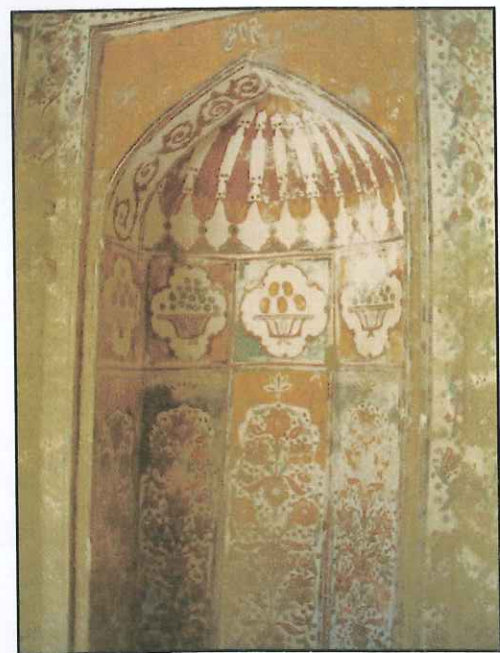
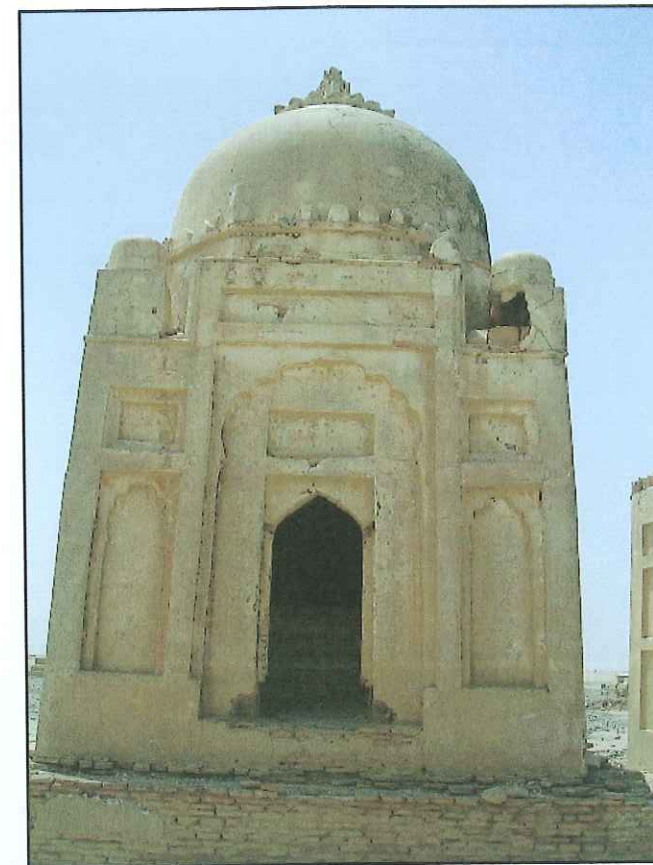
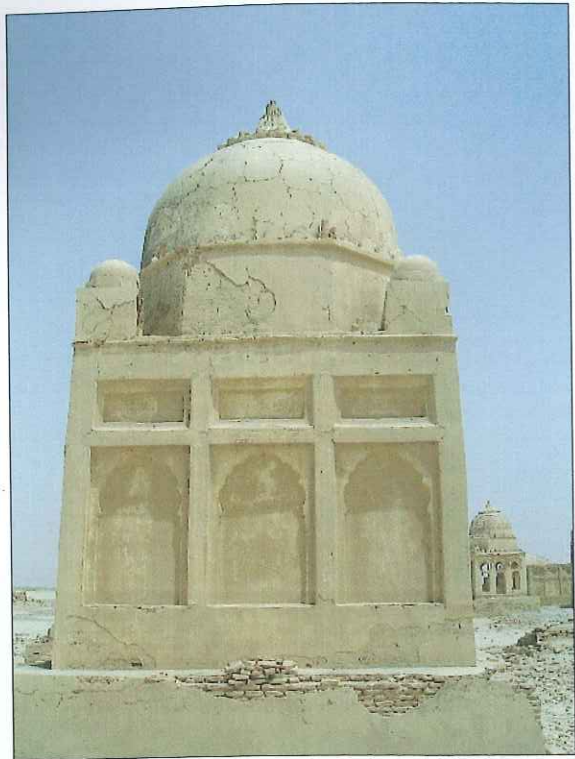

PLAN OF TOMB 07



PROJECT

LOCATION

JOB

DEVELOPED BY;
ARCH: IETIKHAR AHMED KAL HORO

DATE

PRESERVATION & RENOVATION OF JAMALI JA QUBBA TAL: JOHI DISTT: DADU

DEPARTMENT OF ANTIQUITIES GOVT: OF SINDH

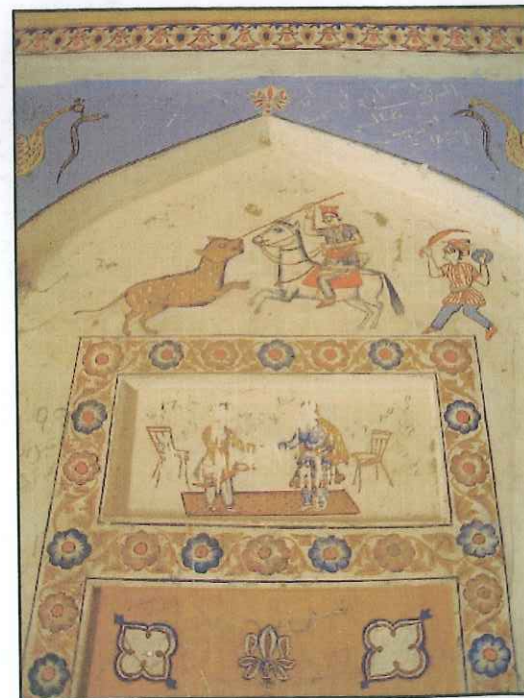
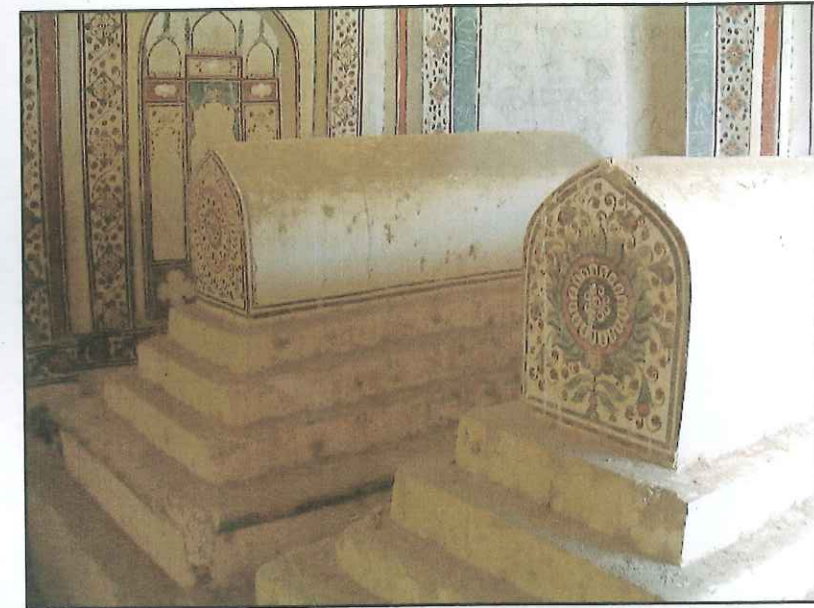
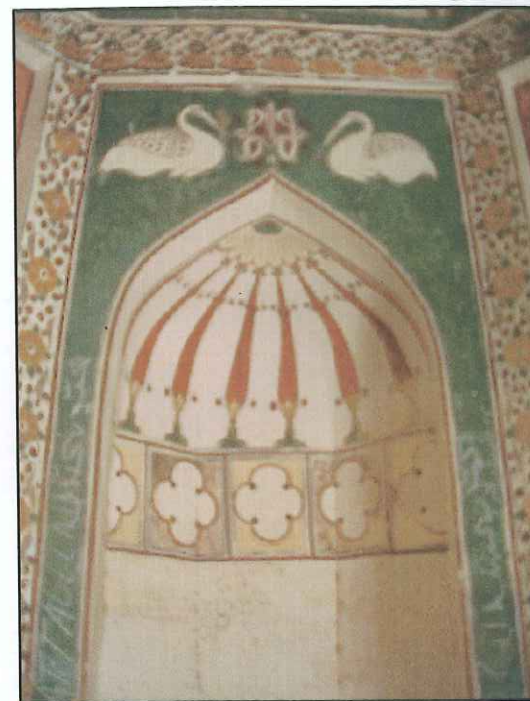

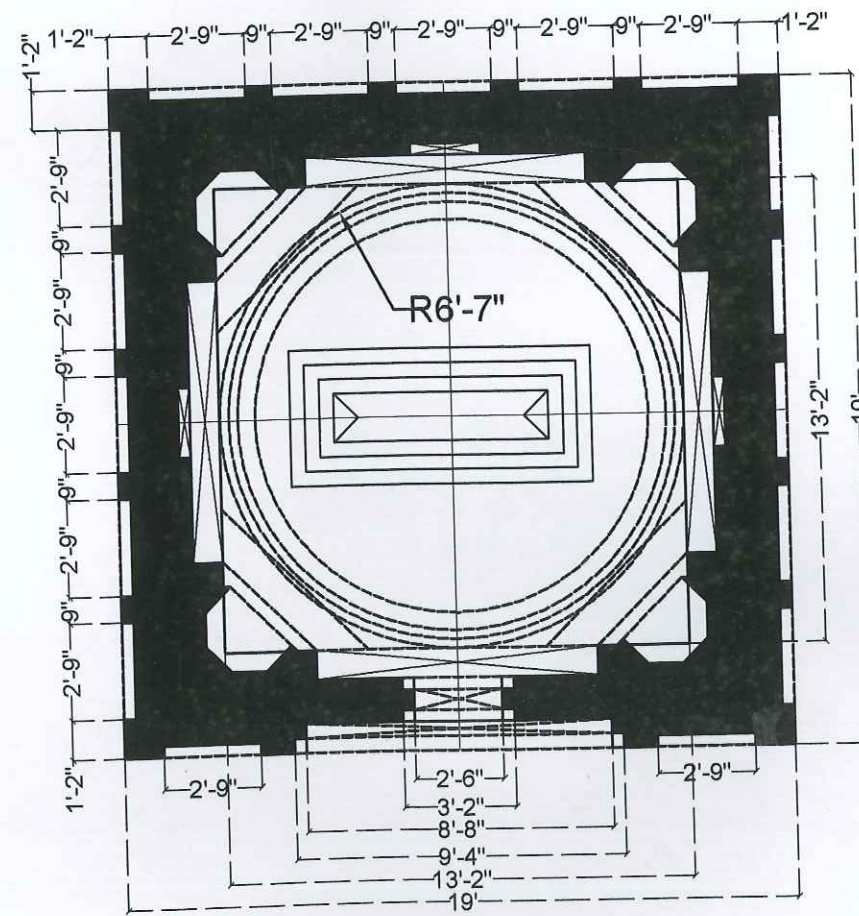
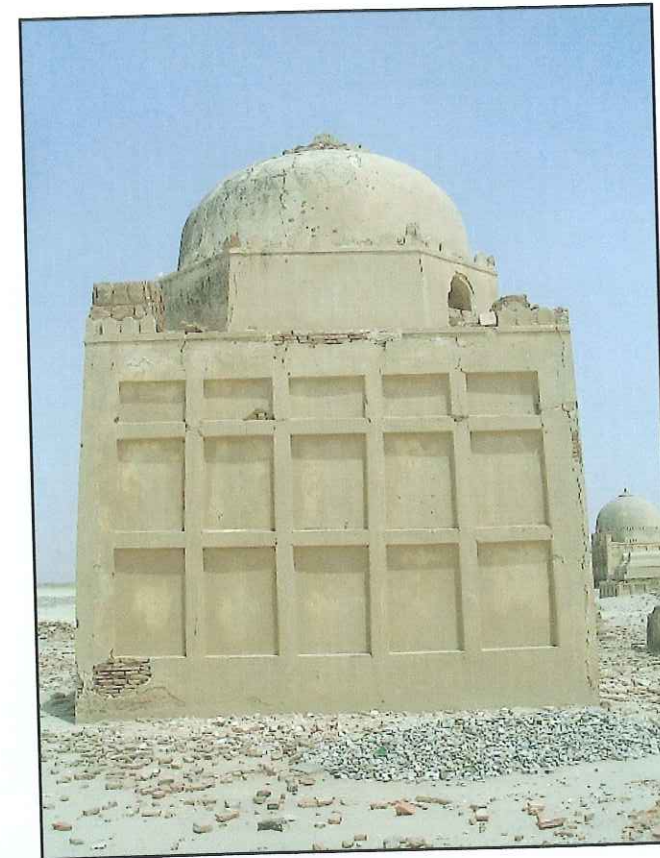
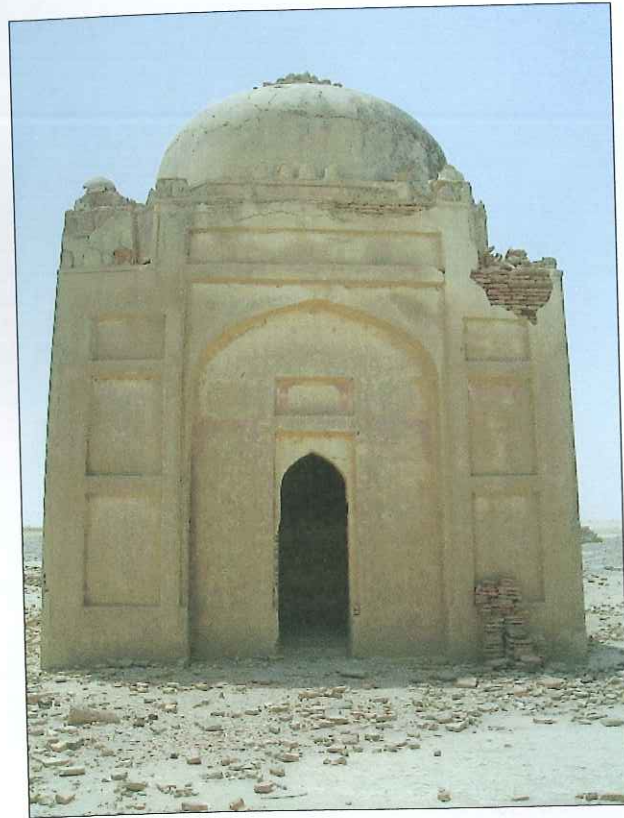

PLAN OF TOMB 08



PROJECT

LOCATION

JOB

DEVELOPED BY;
ARCH: IFTIKHAR AHMED KALHORO

DATE
05.05.2008

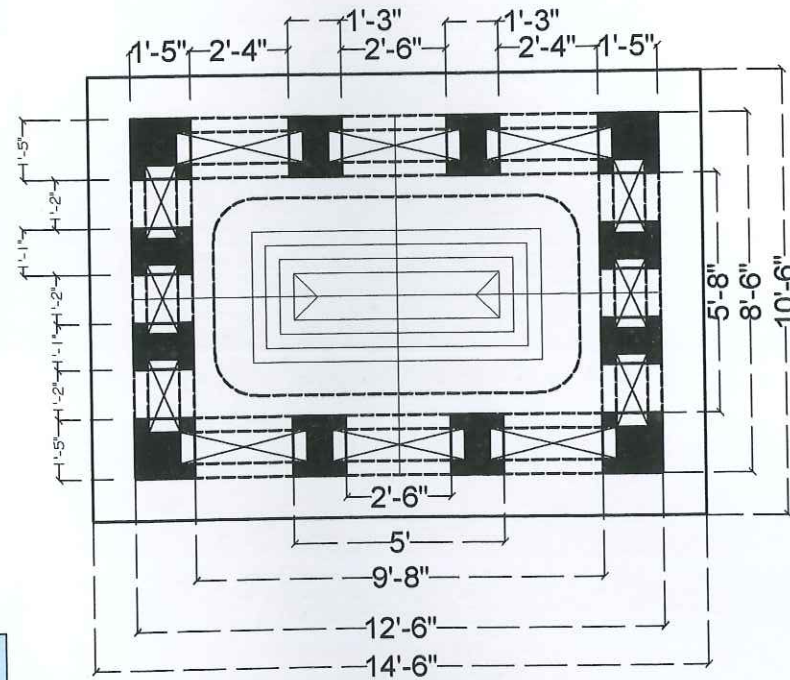

PLAN OF TOMB 09

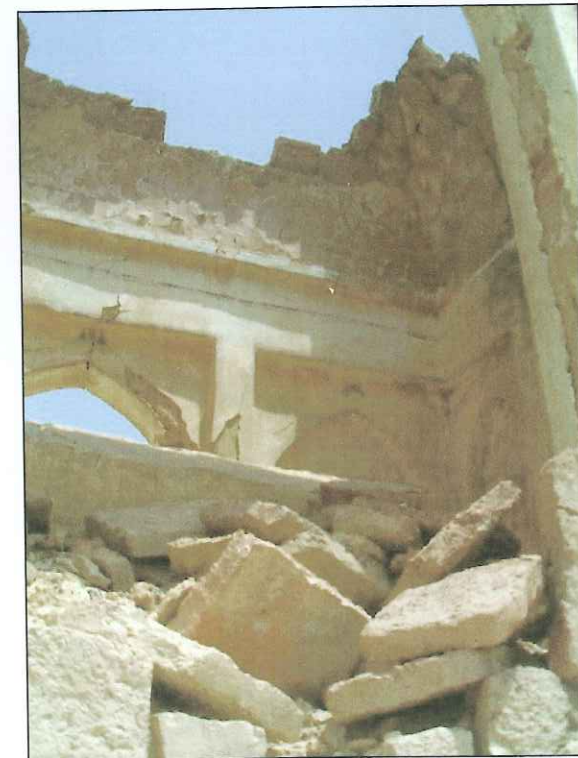

PROJECT

LOCATION

JOB

DEVELOPED BY;
ARCH: IFTIKHAR AHMED KAL HORO

DATE

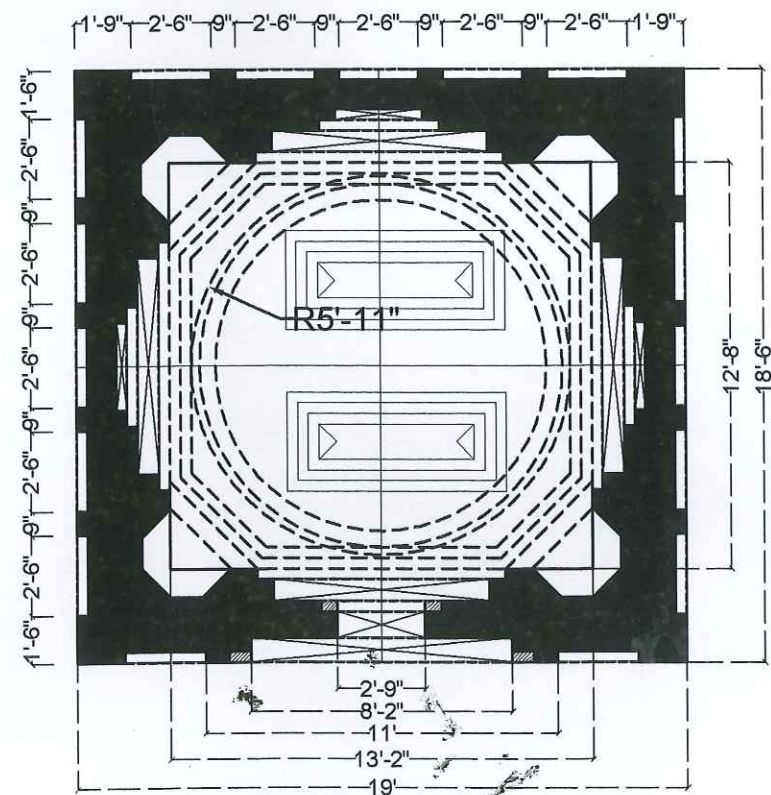
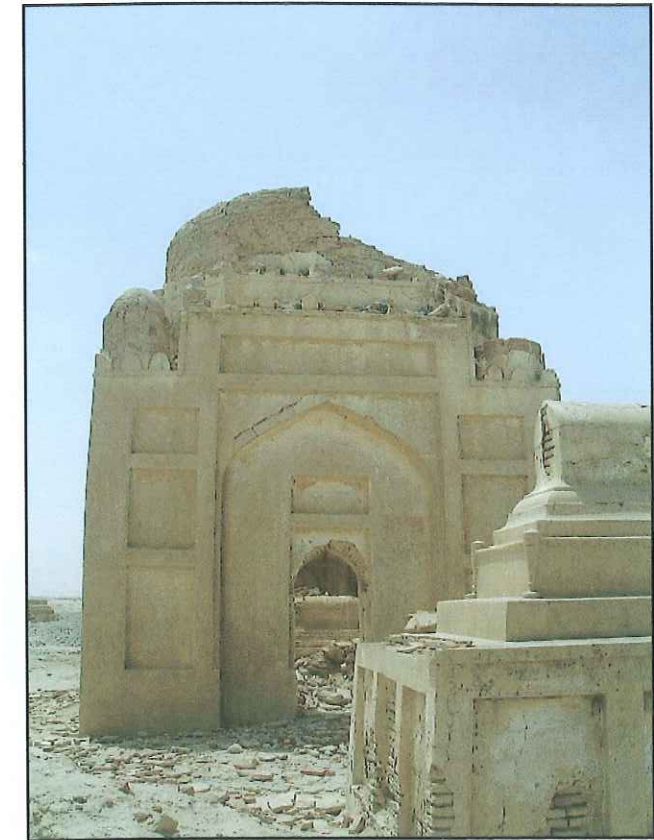

PLAN OF TOMB 10



PROJECT
PRESERVATION & RENOVATION OF

LOCATION
TAL: JOHL DISTRICT DADU

JOB

DEVELOPED BY;
ARCH: IFTIKHAR AHMED KALHORO

DATE



PLAN OF TOMB 11

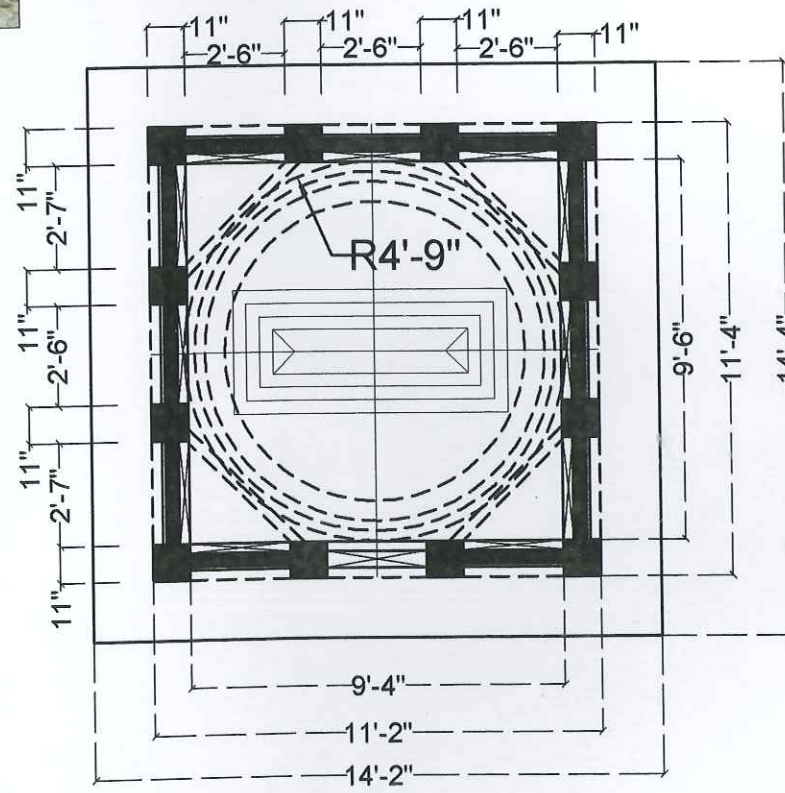

PLAN OF TOMB 11

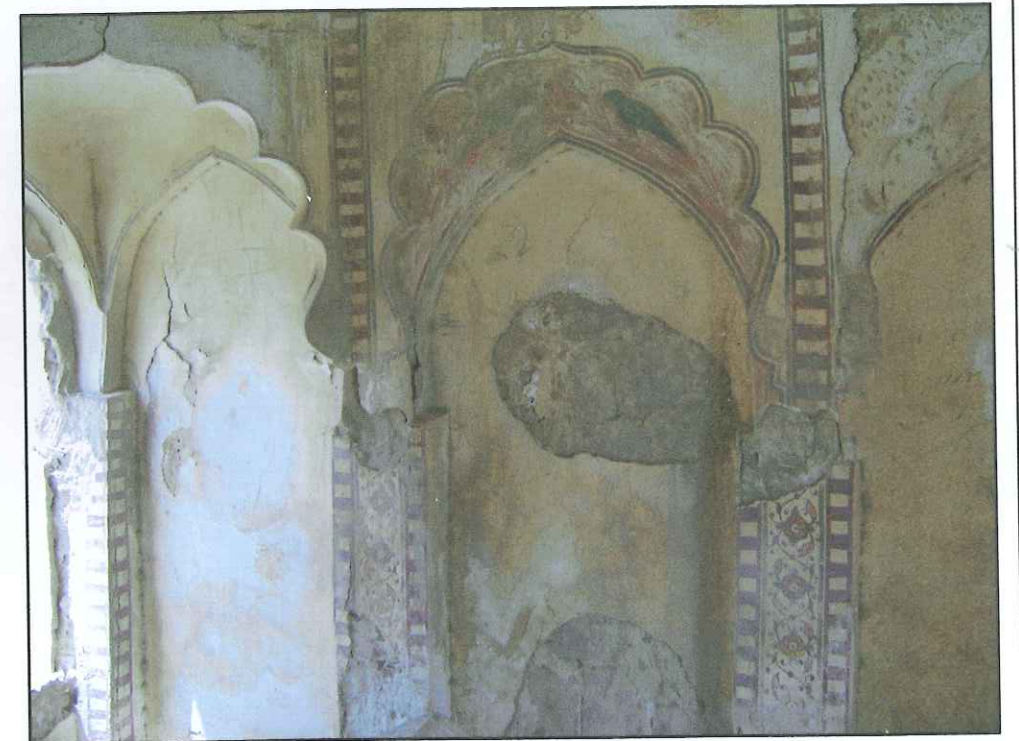
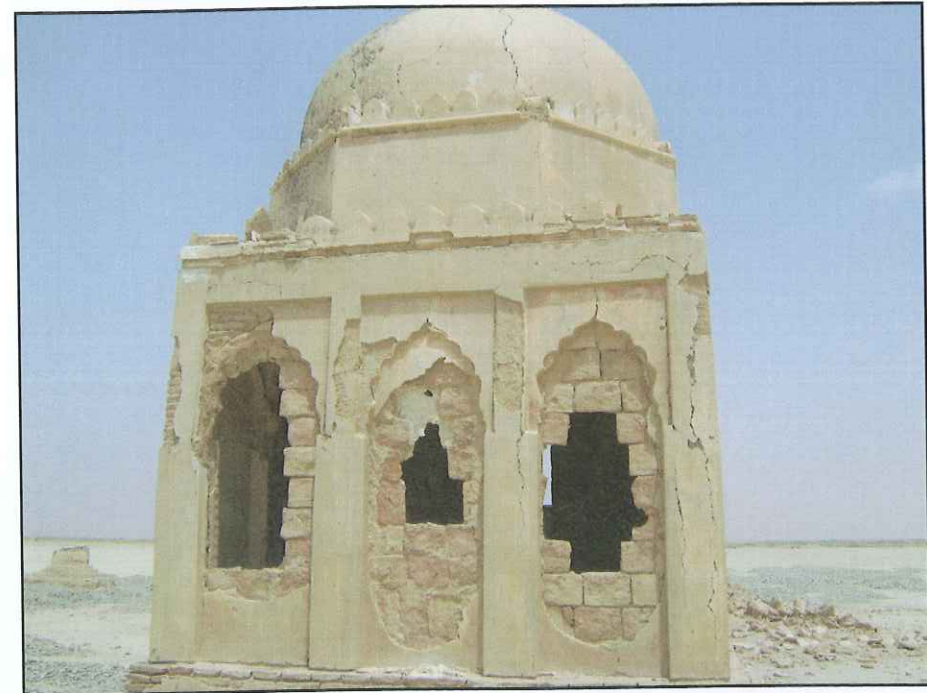

PROJECT

LOCATION

JOB

DEVELOPED BY;
ARCHITECTUR ALMER KALLORO

DATE

Surveyed for SEAS Pakistan Date: 03 May 2008
For a Project of conservation & re-habilitation

Project: Jameel Tombs
Note: All Dimensions are in feet

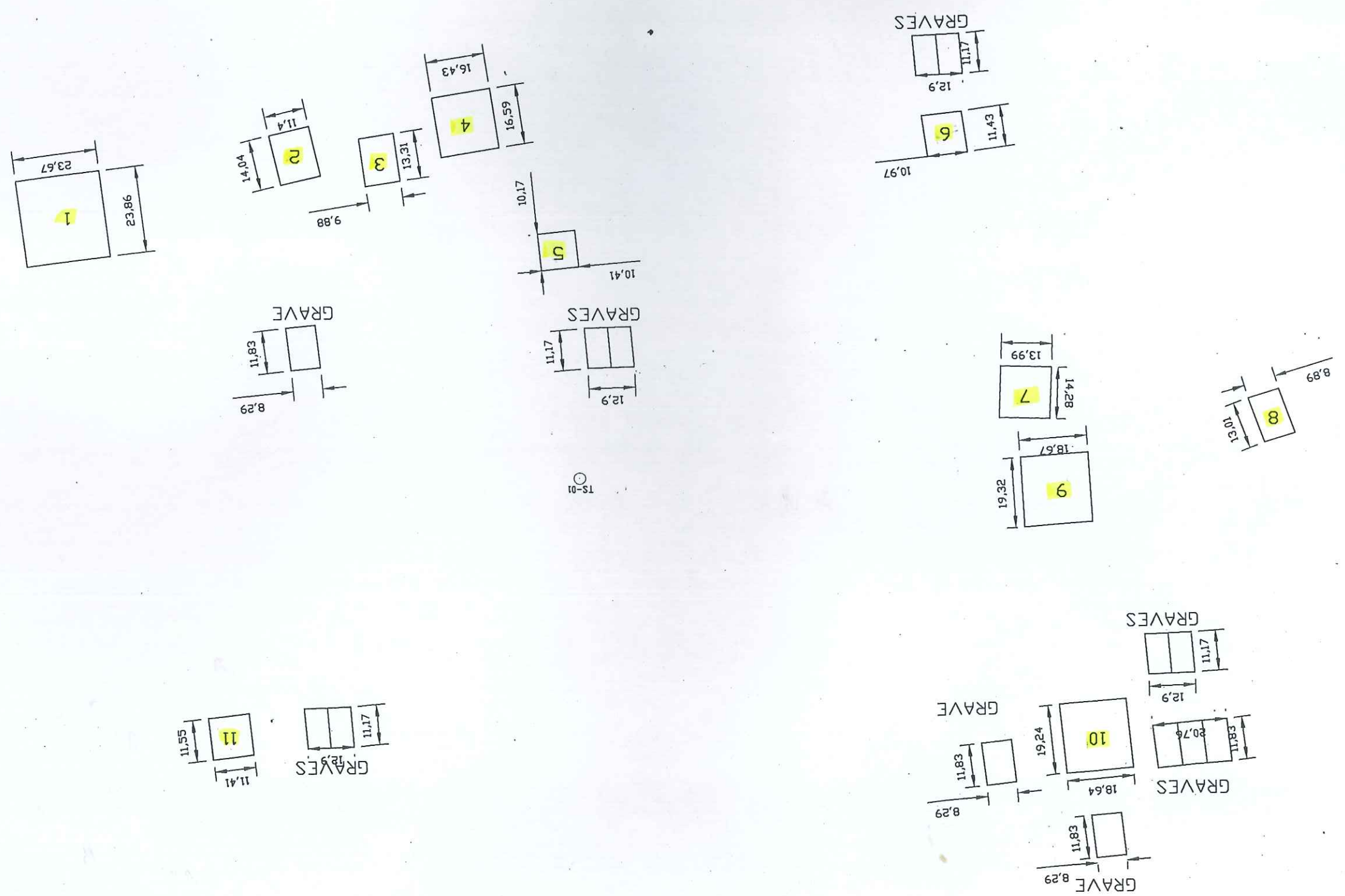

TS-01